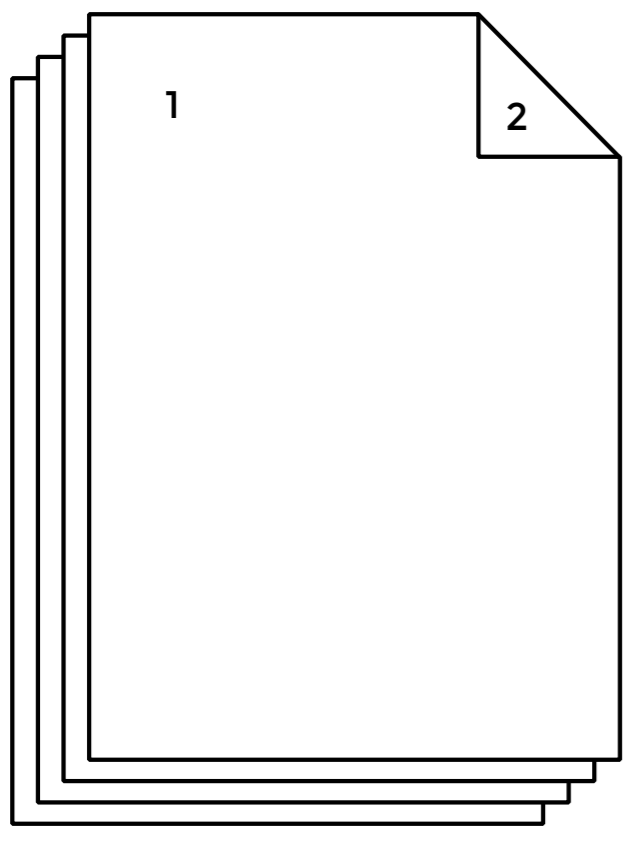
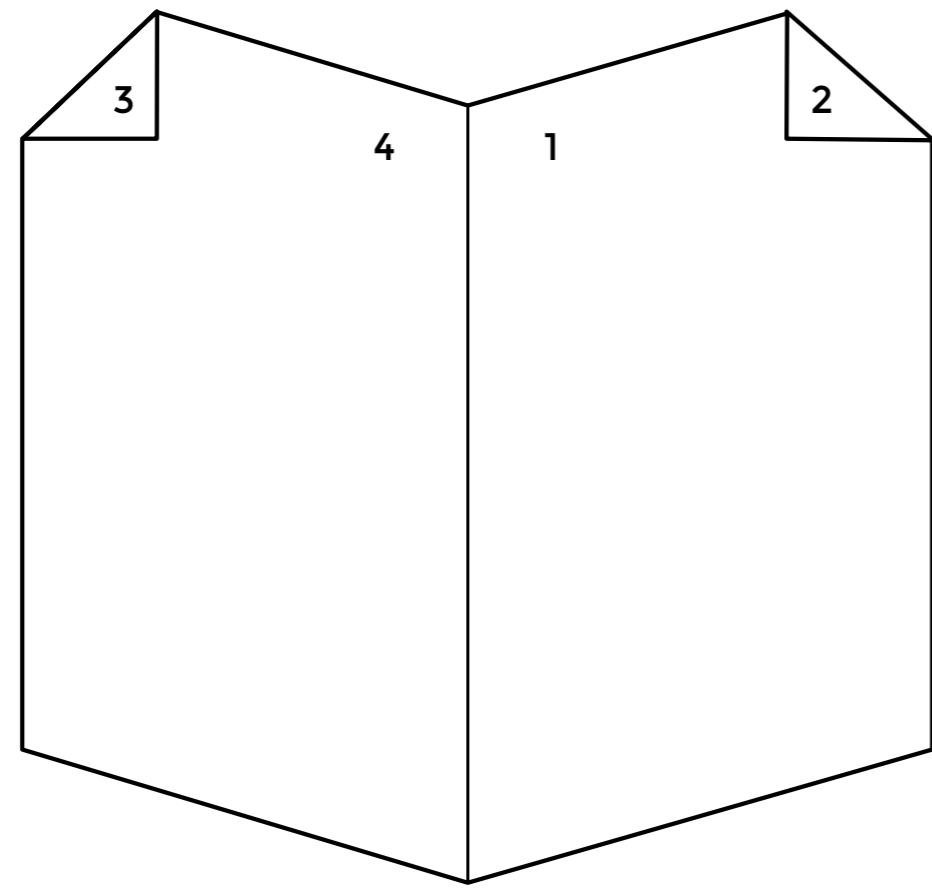

TABLE DES ÉLÉMENTS

PILES DE PAPIER



multiples de 2 (recto-verso)



multiples de 4 (pliées recto-verso)

CAHIERS

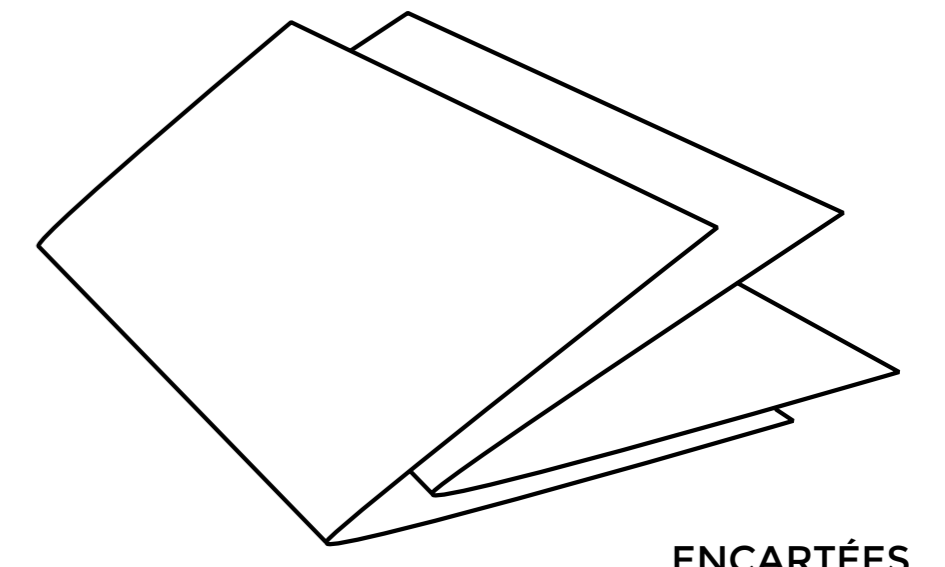
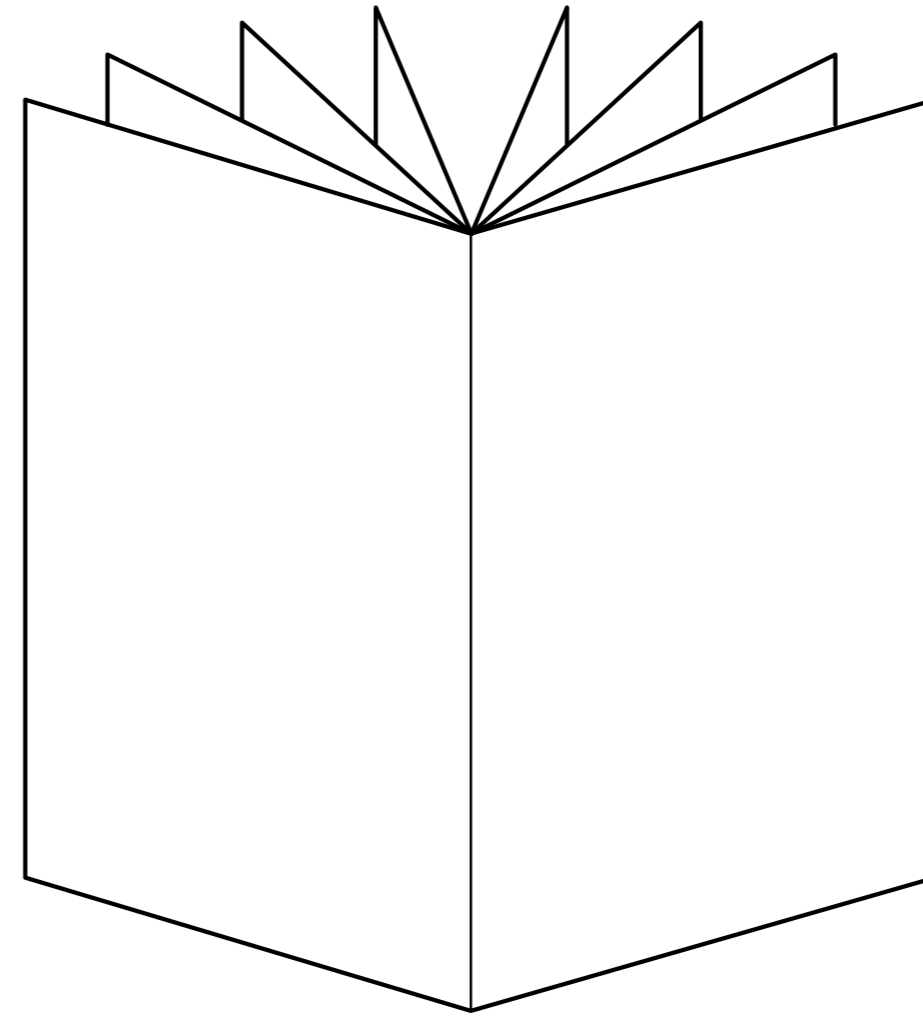

ENCARTÉES

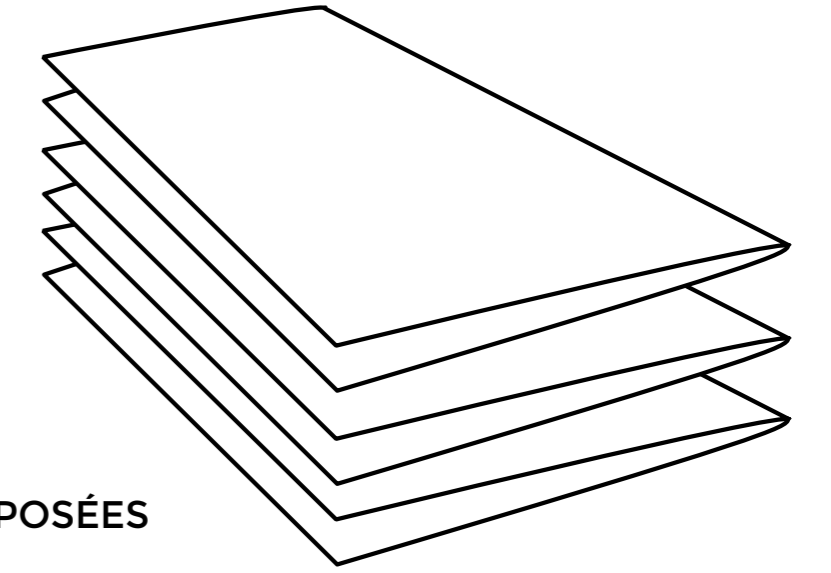

SUPERPOSÉES

AGRAFES



ANNEAUX

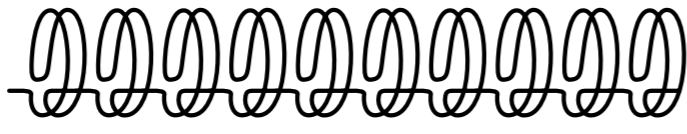

FIL

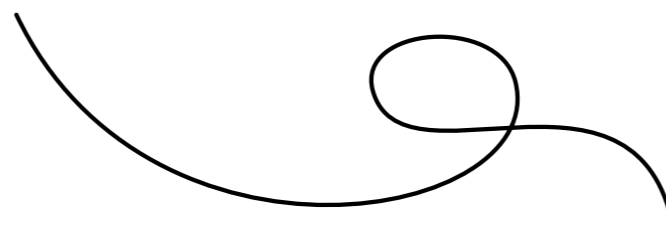

COLLE



ÉLASTIQUE

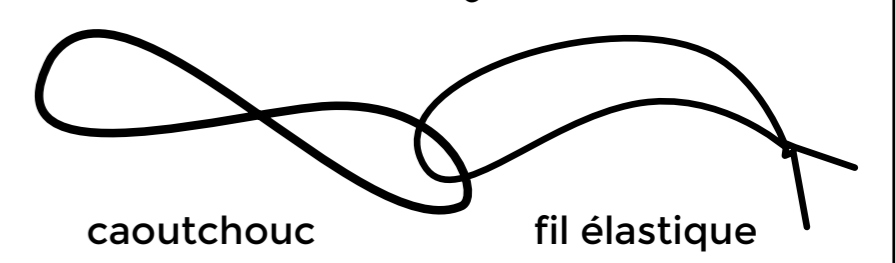

caoutchouc

fil élastique

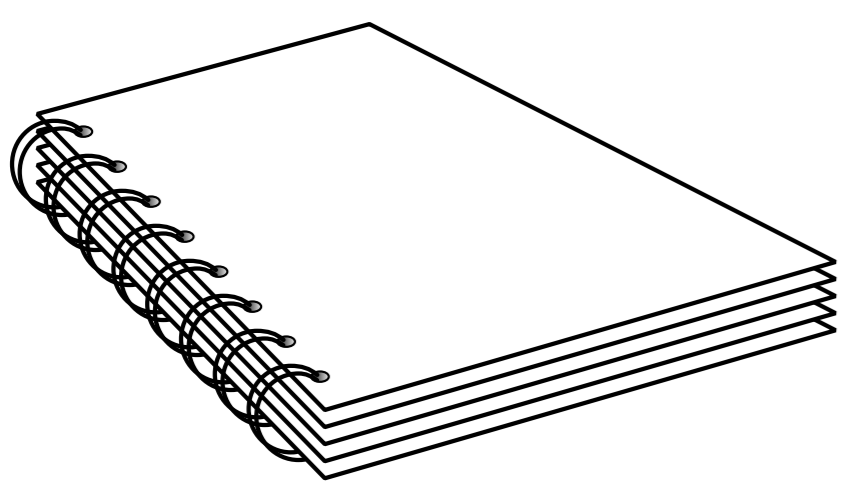

ANNEAUX
(MÉTAL/PLASTIQUE)

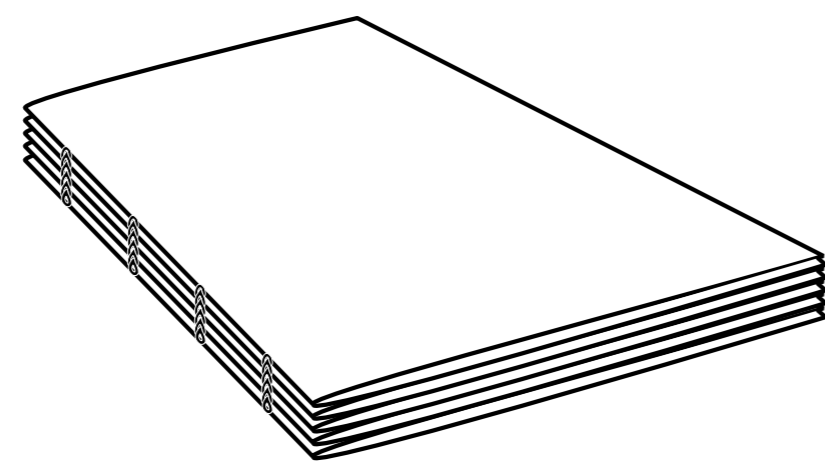

RELIURE
4 AIGUILLES

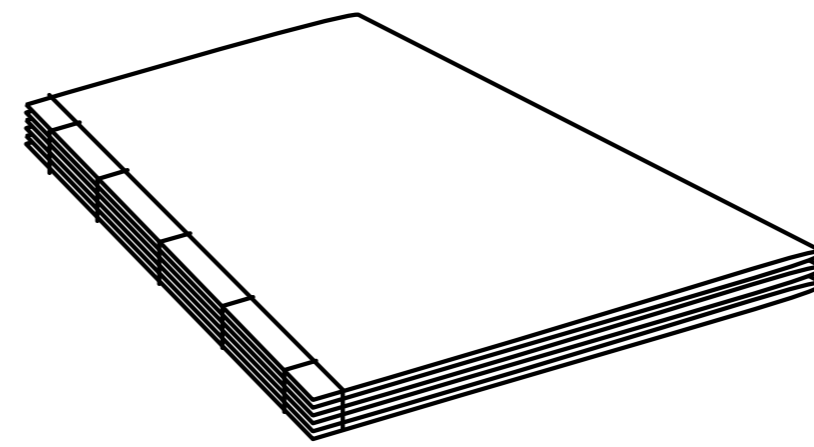

RELIURE
JAPONAISE

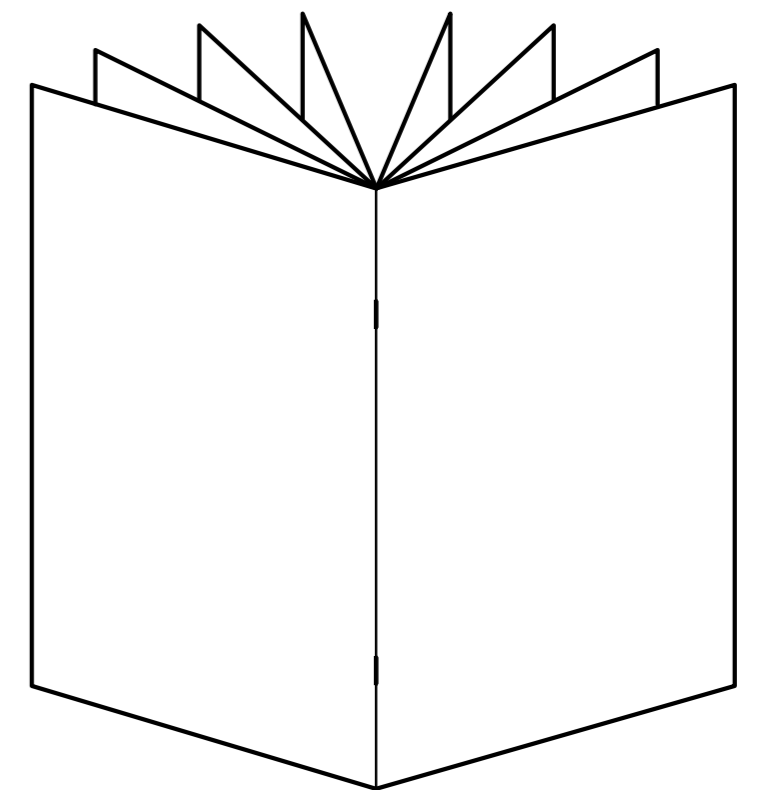

AGRAFÉ

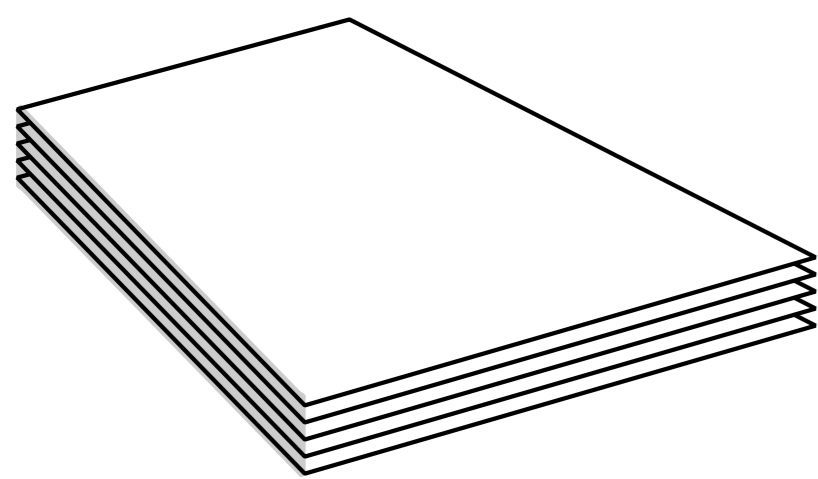

RELIURE COLLE À CHAUD
la moins solide des reliures

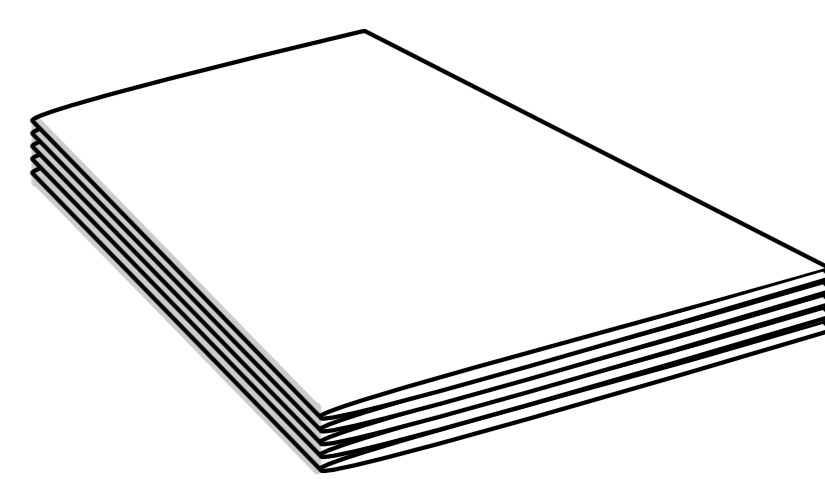

DOS CARRÉ COLLÉ
cahiers cousus et collés

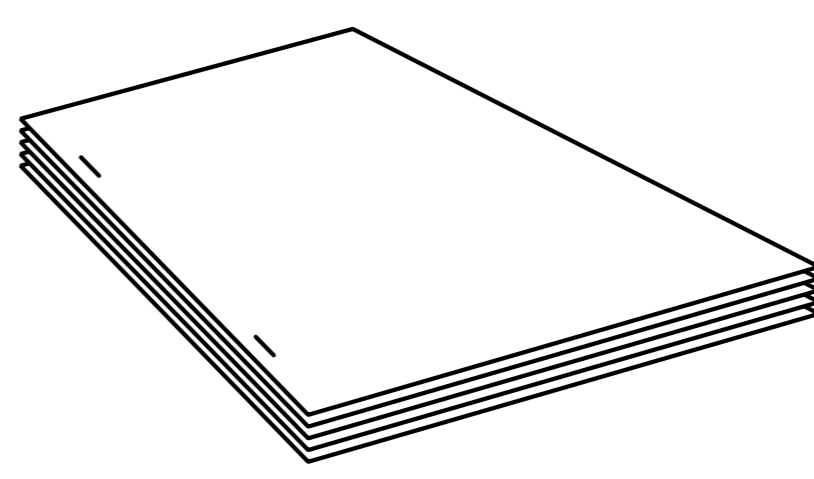

RELIURE
"JAPONAISE"
AGRAFÉE

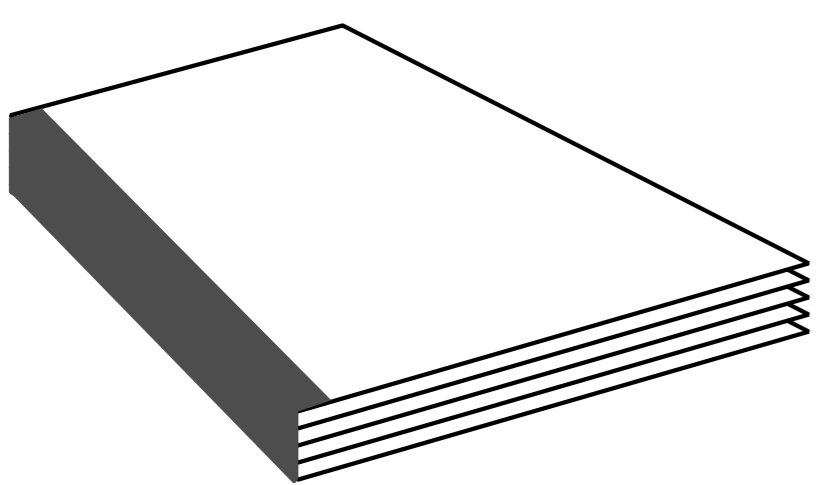

RELIURE COLLE À CHAUD
AVEC UN TISSU

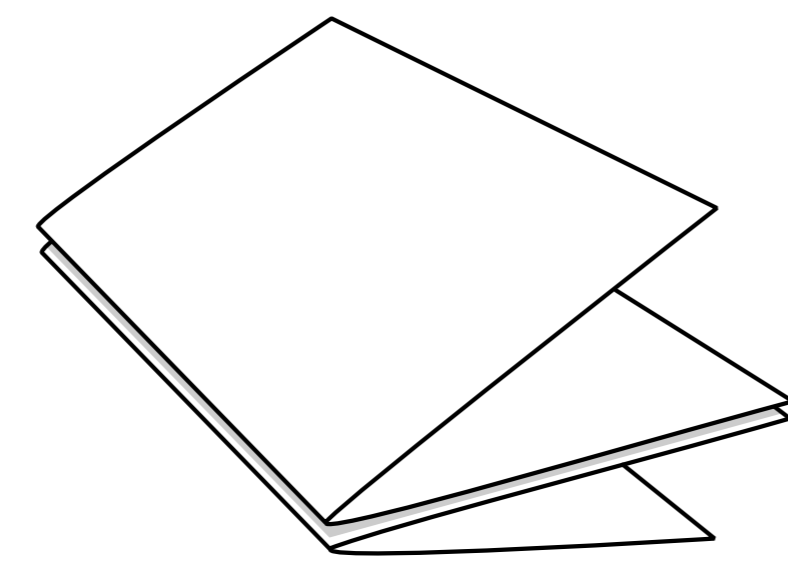

PLIÉ ET
COLLÉ

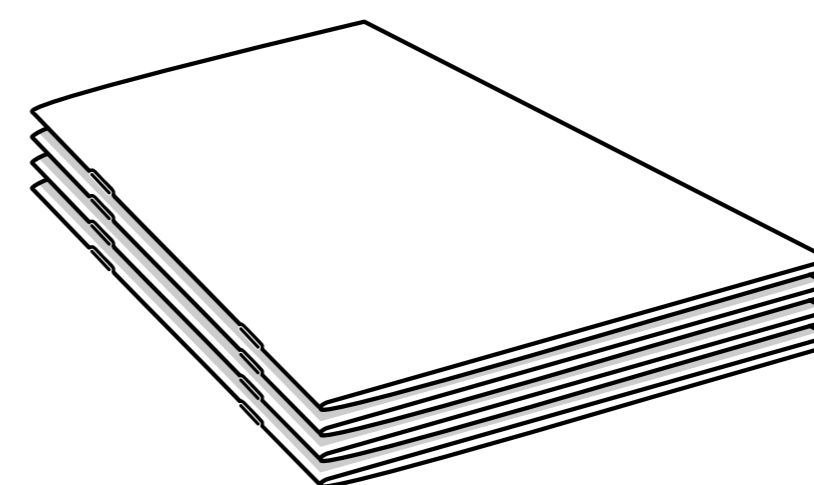

AGRAFÉ
ET COLLÉ

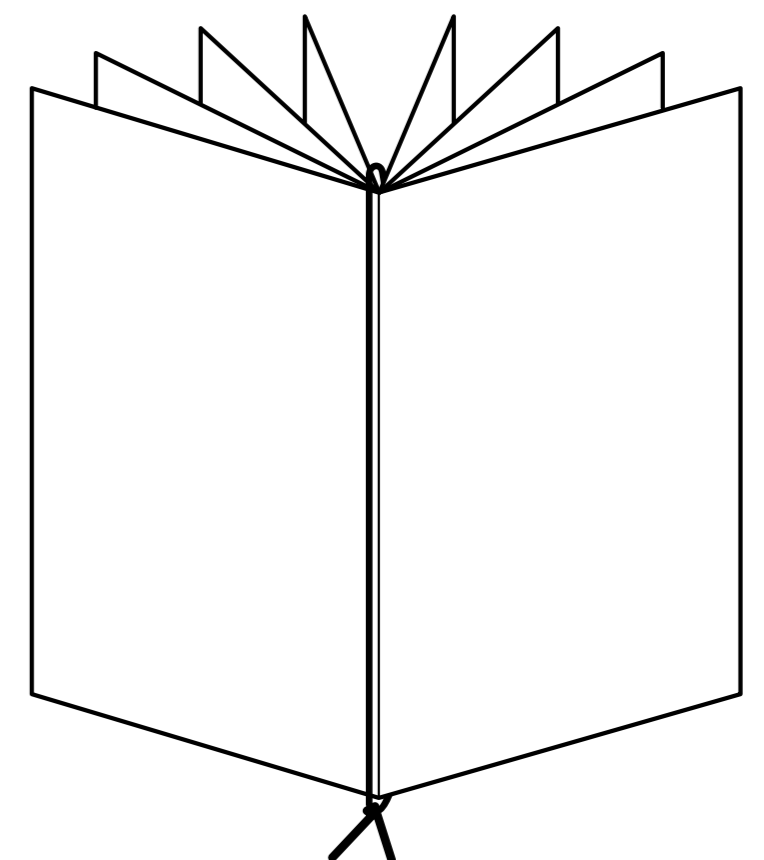

RELIURE AVEC
UN ÉLASTIQUE

COUVERTURE SOUPLE

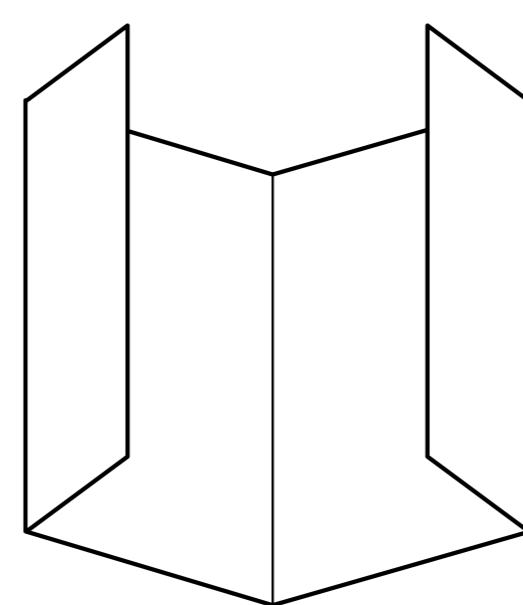
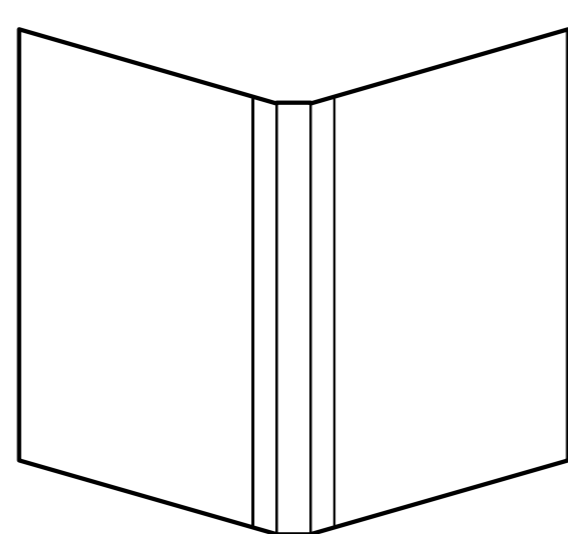
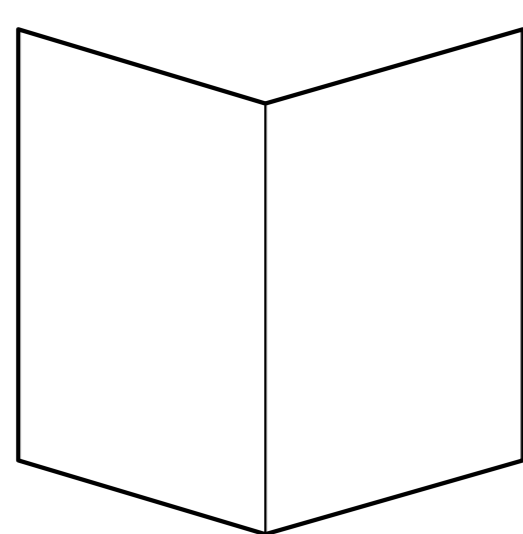
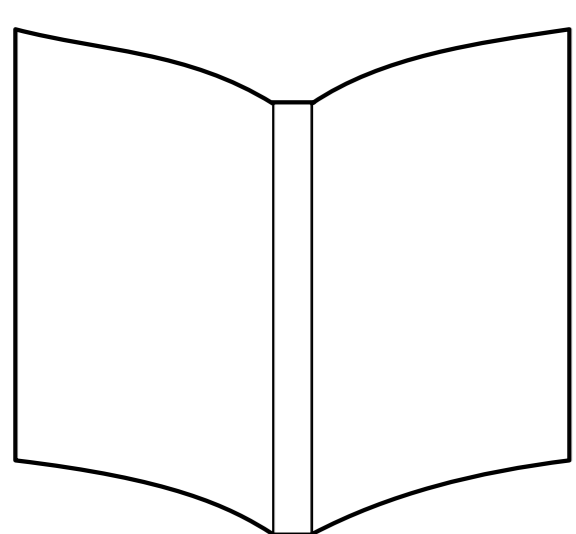

COUVERTURE CARTONNÉE

